

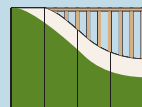

ZIPsystem[®]
R SHEATHING

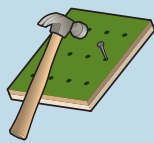

ZIP System[®] R Sheathing

Installation Manual



Contents

- | | | | |
|-----------|---|-----------|--|
| 02 | ZIP System R Sheathing General Notes, Guidelines and Limitations | 07 | ZIP System R Sheathing – Window Installation |
| 03 | ZIP System R Sheathing Installation | 08 | ZIP System R Sheathing – Exterior Cladding Installation: Lap Siding |
| 05 | Structural Bracing to Resist Lateral Forces | 09 | ZIP System R Sheathing – Exterior Cladding Installation: Anchored Masonry Brick Veneer |
| 06 | ZIP System [™] Tape Installation – R Sheathing Panel Seams | | |
-

ATTENTION: This installation guide is intended to provide general information for the designer and end user. The following guidelines will help you properly install the ZIP System R Sheathing. We urge anyone installing this product to read these guidelines in order to minimize any risk of safety hazards and to prevent voiding any applicable warranties. This manual is a general installation guide and does not cover every installation condition. Proper installation shall be deemed to mean the most restrictive requirement specified by Huber Engineered Woods (HEW), local building code, engineer or architect of record or other authority having jurisdiction. You acknowledge that it is solely your obligation for all safety requirements and code compliance. For additional information, contact Huber Engineered Woods LLC.

ZIP System R Sheathing Safety Guidelines

- Follow all OSHA regulations and any other safety guidelines and safety practices.
- Use approved safety belts and/or harnesses or other fall protection equipment.
- Install ZIP System R Sheathing and Tape only in dry conditions and on dry surfaces. Do not install in rain, snow, frost or other slippery conditions.
- Do not apply flame directly to foam layer. Foam will burn and smoke if exposed to an ignition source of sufficient heat and intensity or open flame such as a welder's torch.

What is ZIP System R Sheathing?

ZIP System R Sheathing Panels consist of an oriented strand board panel laminated with a water-resistive facer on the exterior and a rigid foam insulation panel bonded on the opposite (interior) face. When properly installed and taped, ZIP System R Sheathing provides a water-resistive barrier, air barrier and exterior insulation in one product. It may also be used in the construction of braced wall panels or shear walls in certain conditions. See the Structural Bracing to Resist Lateral Forces section of this installation manual for more information.

The OSB substrate complies with Voluntary Product Standard PS2 for wood structural panels and the water-resistive barrier complies as an alternate to the water-resistive barrier prescribed in the code. ZIP System R Sheathing is available with a 1/2-inch or 1-inch foam insulation panel.

ZIP System R Sheathing Includes:

- ZIP System Wall Sheathing Panels with built-in water-resistive barrier and preprinted fastening and tape guides.
- Foam insulation panel.
- ZIP System Tape.

Storage and Handling

- Set panel stack on three supports (stickers) to keep a minimum of 4-inches of clearance above ground level.
- Outdoors, cover panels loosely with a waterproof protective material such as a tarpaulin.
- Anchor covers on top of the stack, but keep away from sides and bottom to assure good air circulation.
- In high moisture environments, cut banding on the panel stack to prevent edge damage.
- Factory applied packaging is intended only for protection during transit.
- Packaged units must be stored indoors or within a covered structure.
- For temporary job-site storage, units should be stacked on pallets at least three inches above ground level and completely covered with a weatherproof covering such as a tarpaulin. The temporary factory-applied packaging should be slit or removed to prevent accumulation of condensation.
- Do not stack more than three units high.

ZIP System R Sheathing Notes and Limitations

- R-Sheathing is approved for wall use only. Do not use on roofs.
- Do not use abutted against stone or masonry without providing a minimum of a 1/2-inch gap.
- Do not install ZIP System Tape in temperatures less than 20° F.
- ZIP System R Sheathing products are not recommended for manufactured housing applications that are built under a federal building code administered by the U.S. Department of Housing and Urban Development (HUD).
- Not intended to replace traditional wood structural panels in applications where the wall sheathing is designed to resist combined wind uplift and shear.
- Do not use in fire-rated assemblies in lieu of a required "wood structural panel."
- Do not apply secondary coatings to the overlay on ZIP System R Sheathing. Any secondary coatings applied to the foam insulation side of the panel must be code recognized with a published ESR and have written approval from Huber Engineered Woods.
- Minimum 1/2-inch gypsum wall board must be installed on the interior side of the wood wall studs as a thermal barrier using code-recognized fasteners per IRC or IBC requirements.
- Only use in buildings of Type V construction or construction permitted under the International Residential Code.
- In areas where the probability of termite infestation is "very heavy" the clearance between R-Sheathing and finished grade shall be no less than 6-inches.

Note: In cladding systems requiring multiple layers of water-resistive barriers, like traditional hard-coat stucco and adhered stone veneers, ZIP System R Sheathing is intended only to replace the first layer.

- Weight of adhered stone veneer shall not exceed 15 psf.

ZIP System R Sheathing Installation

Overview: ZIP System R Sheathing is composed of ZIP System Wall Sheathing Panels, laminated exterior foam panel insulation and ZIP System Seam Sealing Tape. ZIP System R Sheathing Panels should be fully installed before the seam sealing tape is applied. The following manufacturer installation steps and recommendations are presented as a general outline of the installation process. You are fully and solely responsible for all safety requirements. Good construction practices should be followed at all times.

DISCLAIMER: The following steps represent a general overview for proper hold down or strapping installation as needed. Please defer to/consult the manufacturer installation instructions as well as local code requirements.

Step 1. Install any necessary mechanical strapping directly to framing. Any metal straps, ties or other connectors designed to resist uplift, shear or diaphragm loading must be installed prior to ZIP System R Sheathing installation. The requirement for mechanical uplift connections shall be determined by the designer-of-record, local building codes or authority having jurisdiction. Detail A should not be considered typical and only applies when mechanical uplift connections are specified.



Straps, ties and connectors installed on the exterior face of stud will not be visible after ZIP System R Sheathing Panels are installed. Schedule any necessary anchor or nailing inspections accordingly.

DETAIL A

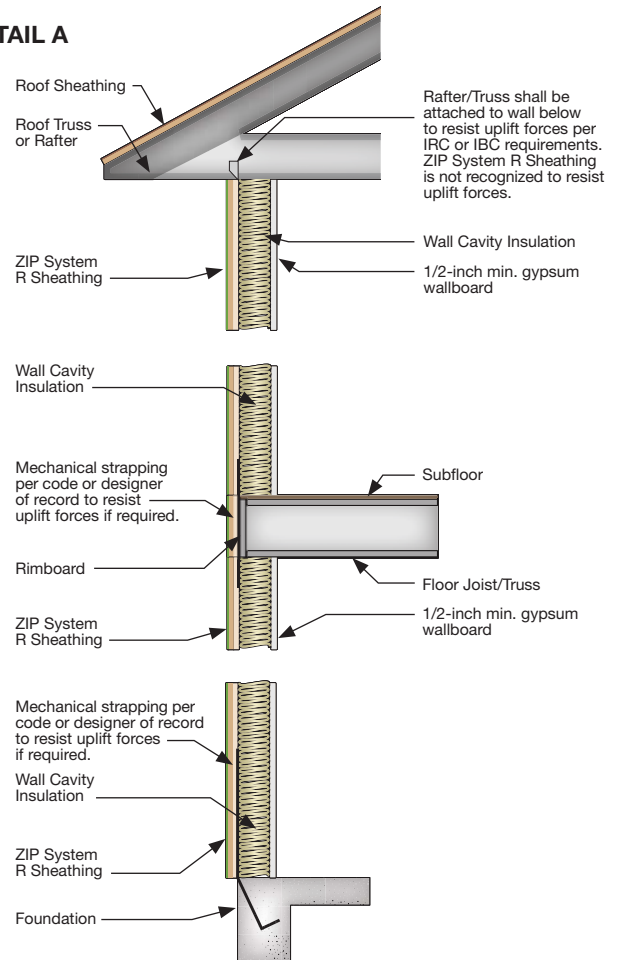

Step 2. Install ZIP System R Sheathing Panels positioned with the water-resistive barrier facing out. The panels may be installed with the long side of the panel oriented either horizontally or vertically to the framing members. Wall panels that are designed to resist lateral shear forces should have solid framing or blocking behind all panel edges. Foam insulation is oversized on one 4-ft and one 8-ft. edge relative to the ZIP Sheathing to accommodate proper gapping of panels. Panels should be installed with foam edges touching. Please coordinate panel field placement and orientation in order to take advantage of this gapping feature.

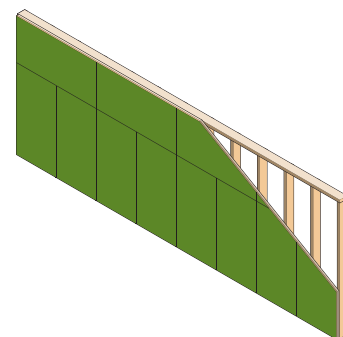

ZIP System R Sheathing Installation

Step 3. Fasten the panels to the framing members with code approved fasteners. Fastener penetration into the wood wall stud should be a minimum of 1½-inches. See section, *Structural Bracing to Resist Lateral Forces*, for fastener options. It is the responsibility of the general contractor to ensure correct fastener type and spacing prior to installation. Apply fasteners 3/8" from panel edge.

ZIP System R Sheathing thickness may influence building interior and exterior dimensions, framing layout or foundation design for anchored veneers. For example: Foundation brick ledges may need to be wider when using ZIP System R Sheathing (See DETAIL H), or wall stud placement may need to be adjusted from building corners to allow for sheathing thickness. Designer and General Contractor should make necessary adjustments (if any) to the design and/or construction methods to accommodate these changes.

DETAIL B

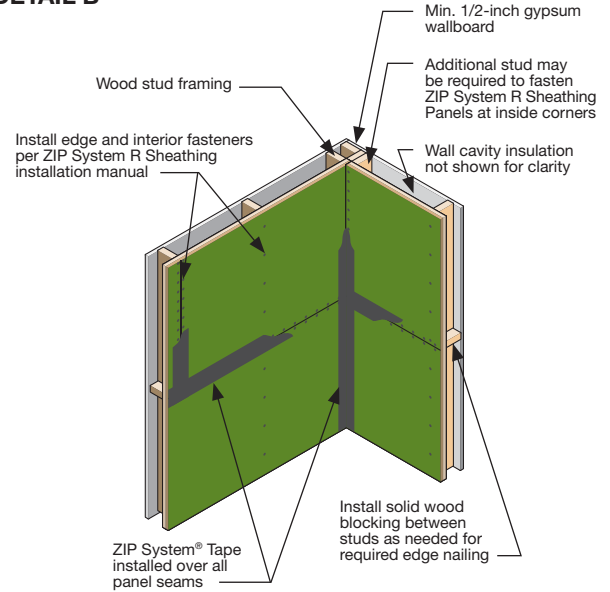

DETAIL C

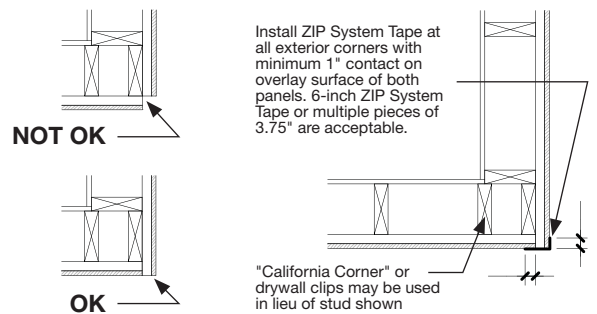
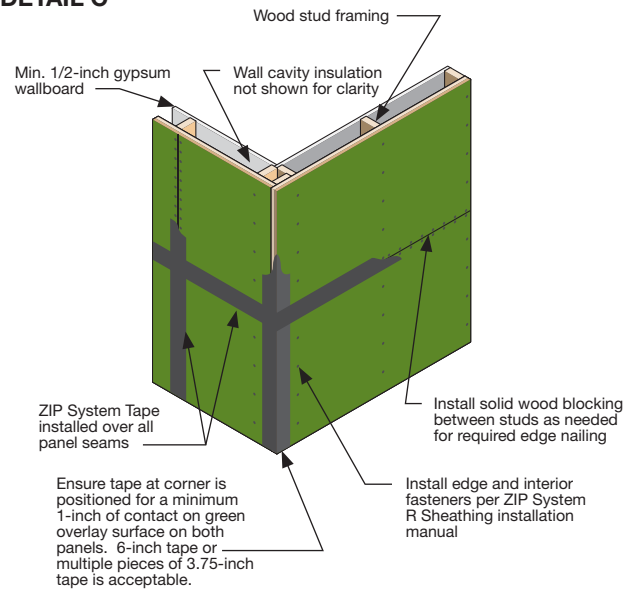

Structural Bracing to Resist Lateral Forces

ZIP System R Sheathing Walls may be designed to resist lateral shear forces by prescriptive or engineered methods in accordance with the International Building and Residential Codes. All seams between panels used to resist lateral loads must be backed by solid wood framing. If the panel is not required for structural bracing, the panels should be installed with minimum 8d common nails, or equivalent, (minimum 1-inch embedment into wood studs) spaced at 6-inches on center on panel edges and 12-inches on center in the field of the panel. Minimum 1/2-inch thick gypsum wallboard must be installed as a thermal barrier in accordance with Chapter 26 of the IBC or Chapter 3 of the IRC.

Installation

R-Sheathing that is not being counted on to resist wind or seismic loads may be attached to framing using 8d common nails (or equivalent). Nails must penetrate the studs at least 1-inch.

ZIP System R-Panels may be used in the construction of braced wall panels in accordance with Method 3 (2006 IRC Section R602.10) or Method 3 (2006 IBC Section 2308.9) as an equivalent alternative to the prescribed wood structural panels ONLY if installed per Table 1 below. All requirements, restrictions and limitations listed in the IRC and IBC regarding the applicability and use of prescriptive wall bracing methods still apply.

Alternatively, engineers may use ZIP System R Sheathing as an alternate to wood structural panels in the construction of wood shear walls as described in Section 2306.4.1 and 2305.3 (as applicable) of the 2006 IBC. The allowable shear loads listed in Table 1 will be used in lieu of values shown in 2006 IBC Table 2306.4.1.

**TABLE 1
FASTENING REQUIREMENTS FOR ZIP SYSTEM R-SHEATHING DESIGNED AS AN ALTERNATE TO METHOD3 WALL BRACING OR AS AN ENGINEERED SHEAR WALL.¹**

ZIP System R-Sheathing Panel Type ^{2,3}	Max. Wall Stud o.c. Spacing (inches)	Minimum Nail		Panel Nail Spacing		Allowable Shear Load (plf) ^{5,6,7}
		Min. Shank Diameter (inches)	Min. Stud Penetration (inches)	Edge Nailing o.c. (inches) ⁴	Field Nailing o.c. (inches)	
R-3	16	0.131	1.5	5	12	211
				4	12	261
	24	0.131	1.5	4	12	261
R-6	16	0.131	1.5	4	12	232
	24	0.131	1.5	4	12	232

1. All panels edges must be backed by framing.

2. R-3 are panels having foam insulation thickness up to 0.5".

3. R-6 are panels having foam insulation thickness greater than 0.5" but not more than 1.0".

4. All fasteners must be a minimum of 3/8" from panel edge.

5. Allowable shear values shown are based on Southern Pine framing lumber. For framing of other species: (1) find specific gravity for species of lumber in AF&PA NDS. (2) Find shear value from Table 1 above for nail size and multiply value by the following factor: Specific Gravity Adjustment Factor = [1-(0.5-SG)], where SG = Specific Gravity of the framing lumber. This adjustment factor shall not be greater than 1.

6. Shearwalls have a maximum height-to-width aspect ratio of 2:1.

7. The allowable shear capacity may be increased by 40% for wind in accordance with IBC Section 2306.4.1.

ZIP System Tape Installation – R Sheathing Panel Seams

Apply ZIP System Tape after ZIP System R Sheathing Panels are fully fastened to wall framing. Only ZIP System Tape should be used to seal the seams of ZIP System R Sheathing. Ensure that the panel surface is dry and free of sawdust and dirt prior to taping. ZIP System Tape is a contact tape that requires application pressure for an adequate seal.

Step 1. Tape all seams using ZIP System Tape. Ensure that the tape is centered over the seam within +/- 1/2-inch to provide adequate coverage and that wrinkles in tape are minimal.

Use the ZIP System Tape gun or roller to apply pressure to the tape and smooth out any wrinkles.

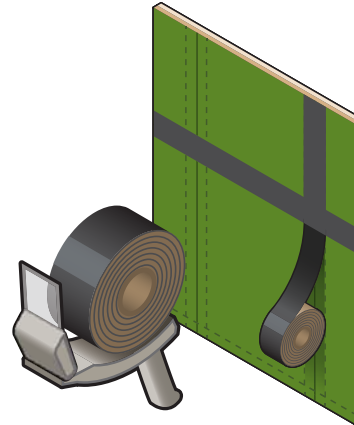

Step 2. Wherever tape splices occur at a horizontal or vertical seam, create an overlapping splice of at least 3-inches.

At T-joints, the tape pieces should overlap by at least 1-inch. Apply pressure onto the surface of the tape to ensure a secure bond between the panel and the tape.

Use the ZIP System Tape gun or roller to apply pressure to the tape and smooth out any wrinkles.

Take special care to remove any voids and/or trapped air at splice areas and T-joints.

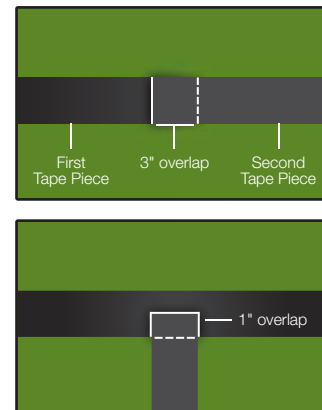

Step 3. Tape inside and outside corner seams.



Tip: When taping inside corner seams, it is helpful to cut a manageable length of ZIP System Tape and hold the ends in the middle using only your index fingers and thumbs. Slightly pulling both ends of the tape causes the tape edges to naturally curl inward. With the tape in tension, place it in the inside corner and then finish using the ZIP System Corner Tool. Repeat as you go up the full height of the wall.

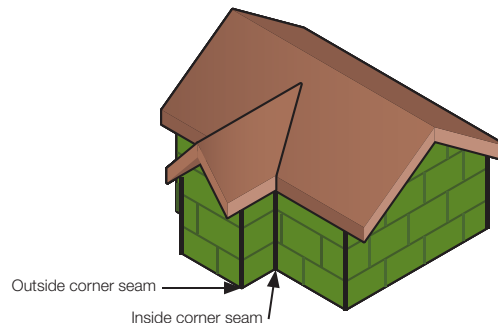

ZIP System R Sheathing – Window Installation

DISCLAIMER: The following steps represent a general overview for the proper installation of window flashing. Please defer to/consult the installation instructions of your window manufacturer as well as local code requirements. It is the responsibility of the General Contractor to coordinate rough opening dimension with window dimensions and install any necessary extensions as needed.

- Step 1.** Install sill/pan flashing that satisfies the requirements of ASTM E 2112-07. 6-inch ZIP System Tape may be used as pan flashing if installed in accordance with ASTM E 2112-07, Type III Pan Flashing – Multiple Pieces. Other adhesive-based flashing tapes may be used if they satisfy ICC-ES AC-148, *Acceptance Criteria for Flexible Flashing Materials*.
- Step 2.** Apply sealant around inside face of window mounting flange. Sealant must be gapped at the bottom flange to permit drainage if used. Install and level window per manufacturer's installation instructions. Verify sealant compatibility with window manufacturer. When using ZIP System Tape, 100% silicone, butyl and polyurethane sealants are acceptable. DO NOT use latex sealants.
- Step 3.** Cut two pieces of ZIP System Tape (6-inch ZIP Tape is recommended) or other adhesive backed flashing tape (must meet ICC-ES AC148) and apply to each of the window jamb flanges. Ensure the jamb flashings overlap the sill flashing.
- Step 4.** Cut a length of ZIP System Tape (6-inch ZIP Tape is recommended) or other adhesive backed flashing tape (must meet ICC-ES 148) and apply to the head flange on the window. Ensure the head flashing overlaps the jamb flashing.

Once the tape is in place, apply sufficient pressure to the tape surfaces using the ZIP System Tape gun or roller.

DO NOT tape bottom window flange.

DETAIL D

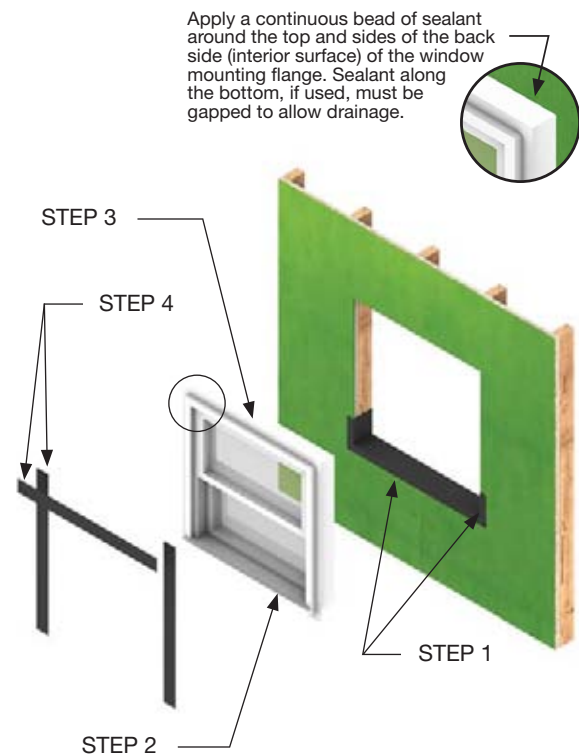

- Step 5.** From the interior of the rough opening, apply low-pressure polyurethane foam (for windows) between the rough opening and the window frame. (Caulk sealant compatible with the flashing and backer rod may be used in lieu of polyurethane foam.) When using ZIP System Tape, 100% silicone, butyl and polyurethane sealants are acceptable.

DETAIL E

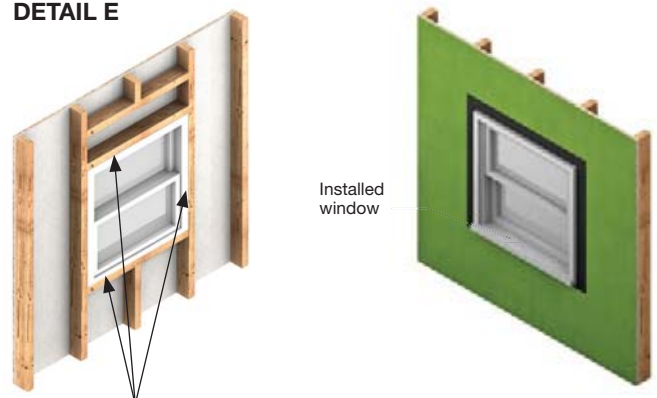

ZIP System R Sheathing – Exterior Cladding Installation

DISCLAIMER: The following steps represent a general overview for the proper exterior cladding installation. Please defer to/consult the installation instructions of your cladding manufacturer as well as local code requirements.

Lap Siding

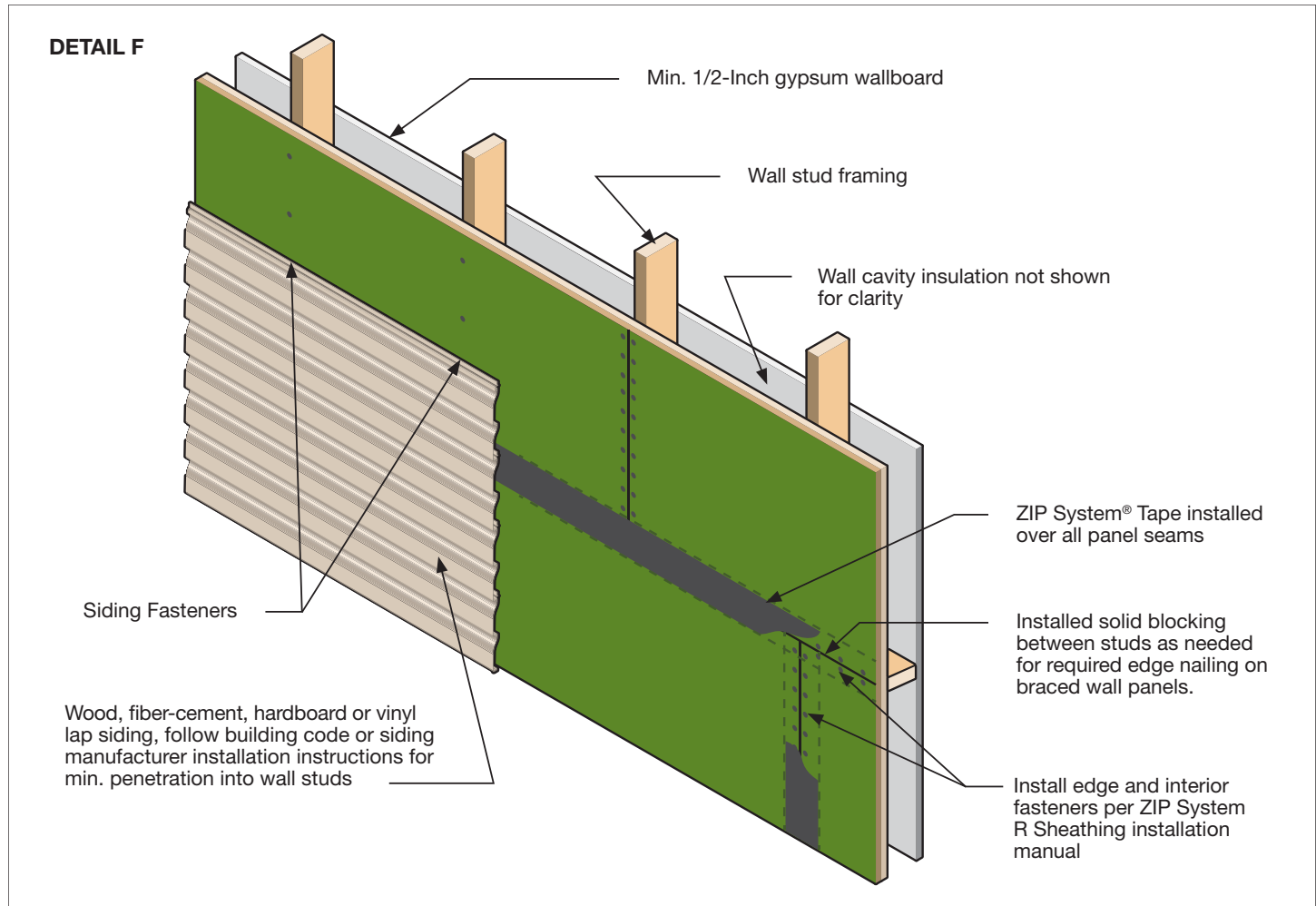

It is the responsibility of the General Contractor to ensure that fasteners used to install lap siding are of adequate length to satisfy the requirements of governing building codes and siding manufacturer's installation instructions.

ZIP System R Sheathing – Exterior Cladding Installation

Anchored Masonry Brick Veneer

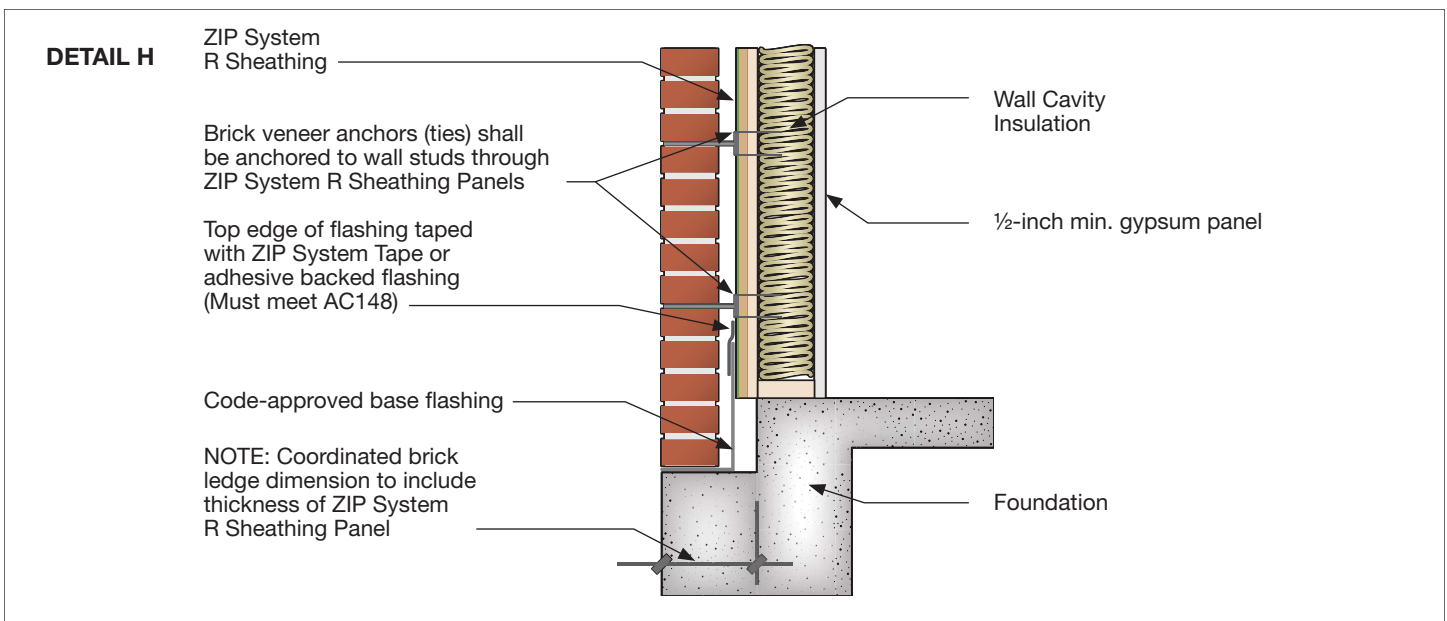
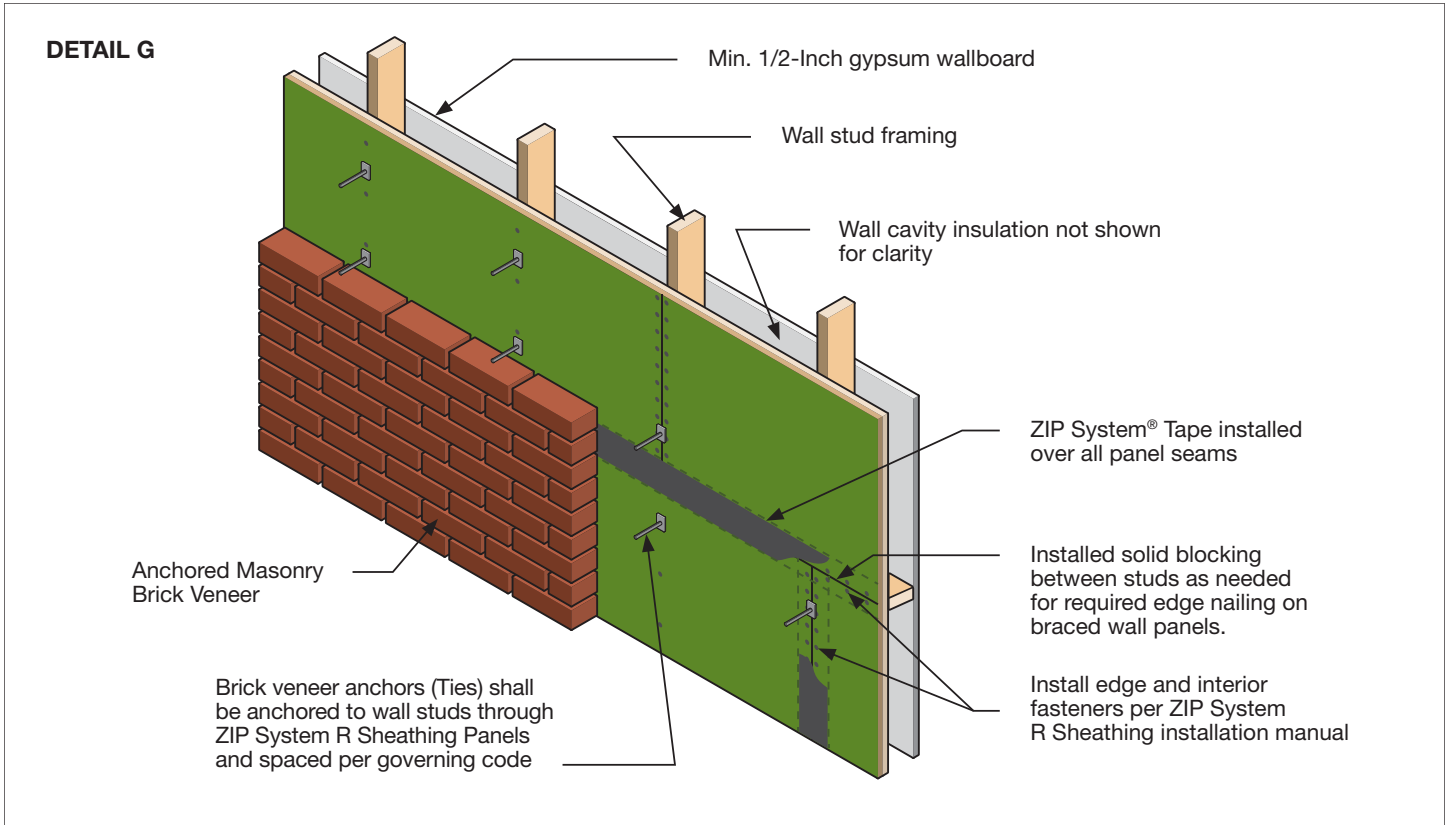

It is the responsibility of the General Contractor to ensure that fasteners used to install brick veneer anchors (Ties) are of adequate length to satisfy the requirements of governing building codes.

To learn more about our ZIP System R Sheathing call 1.800.933.9220 or visit ZIPsystem.com