



ZIPsystemTM
ROOF & WALL SHEATHING

FASTER. TIGHTER. ENERGY EFFICIENT.

FROM THE
CREATORS OF **AdvanTech**SM

ZIP System[®] Roof & Wall Sheathing **INSTALLATION MANUAL**

Sales Office: 10925 David Taylor Dr., Suite 300 Phone: 800-933-9220 zipsystem.com
Charlotte, NC 28262 Fax: 704-547-9228

©2008 Huber Engineered Woods LLC. AdvanTech and The Next Generation of Walls are registered trademarks of Huber Engineered Woods LLC. ZIP System, the accompanying ZIP System logo and design and Stormex are trademarks of Huber Engineered Woods LLC. Huber is a registered trademark of J.M. Huber Corporation. **HUB313-12/10**

another innovation from



ZIP System® Roof & Wall Sheathing INSTALLATION MANUAL



FASTER. TIGHTER. ENERGY EFFICIENT.

Contents

02	ZIP System® Sheathing Installation On Roofs	08	ZIP System® Roof & Wall Sheathing - Window Installation Flanged Windows & Brick Mould Windows
03	ZIP System™ Tape Installation - Roof Panel Seams	09	ZIP System® Roof & Wall Sheathing - Window Installation Brick Mould Windows (continued)
04	ZIP System™ Tape Installation - Roof Panel Seams (continued)	10	ZIP System® Roof & Wall Sheathing - Penetration Openings
05	Roof Covering Installation Instructions	11	ZIP System® Roof & Wall Sheathing Installation Details
06	ZIP System® Roof & Wall Sheathing Installation	12	ZIP System® Roof & Wall Sheathing Installation Details (continued)
07	ZIP System™ Tape Installation - Panel Seams		

ATTENTION: This installation guide is intended to provide general information for the designer and end user. The following guidelines will help you safely and properly install the ZIP System® Roof & Wall sheathing. We urge you, and anyone installing this product, to read these guidelines in order to minimize any risk of safety hazards and to prevent voiding any applicable warranties. This manual is a general installation guide and does not cover every installation condition. Proper installation shall be deemed to mean the most restrictive requirement specified by Huber Engineered Woods (HEW), local building code, engineer or architect of record or other authority having jurisdiction. You are fully and solely responsible for all safety requirements and code compliance. For additional information contact Huber Engineered Woods LLC.

ZIP System® Roof & Wall Sheathing Safety Guidelines

- Follow all OSHA regulations and any other safety guidelines and safety practices during installation and construction.
- Use approved safety belts and/or harnesses or other fall protection equipment.
- Install ZIP System panels and tape only in dry conditions and on dry surfaces. Do not install in rain, snow, frost or other slippery conditions.
- Wear rubber-soled or other high-traction footwear while installing ZIP System sheathing in a roof application. Do not wear footwear with worn soles or heels.
- Ensure the roofing surface is free from oil, chemicals, sawdust, dirt, tools, electric cords, air hoses, clothing and anything else that might create a tripping hazard.
- Install temporary toe boards along the ZIP System sheathing roof surface.

What Is ZIP System® Roof & Wall Sheathing?

ZIP System Roof & Wall sheathing is code-recognized as a wood structural panel, roofing underlayment (ICC-ES ESR-1473), water-resistive barrier and air barrier (ICC-ES ESR-1474). ZIP System Roof & Wall sheathing has a built-in moisture barrier that lets you say good-bye to building paper or housewrap on the walls and felt paper on the roof.* Simply install the panels, tape the seams, and you have a structural wall sheathing, water-resistive barrier and air barrier or a structural roof sheathing and roofing underlayment all from one product.

ZIP System Roof & Wall sheathing can be used with a range of exterior claddings and roof coverings. Approved wall coverings include brick, vinyl, stone, wood fiber cement, wood and cedar shakes, traditional hard coat stucco and specified drainable EIFS applications, however it is not recommended for use with adhesively attached EIFS. Approved roof coverings include asphalt-fiberglass shingles, metal tiles and panels, clay and concrete tiles, slate and slate-type shingles and wood shakes and shingles. Follow all cladding and roof covering manufacturer's installation instructions.

ZIP System Roof & Wall sheathing can be used on buildings of Type III (Roof Applications ONLY) and Type V construction and construction permitted under the IRC.

ZIP System® Roof & Wall Sheathing Includes:

- ZIP System sheathing panels with built-in moisture barrier with preprinted fastening and tape guides
- ZIP System tape

Storage and Handling

- Set panel stack on three supports (stickers) to keep off the ground.
- Outdoors, cover panels loosely with waterproof protective material.
- Anchor covers on top of the stack, but keep away from sides and bottom to assure good air circulation.
- In high moisture environments, cut banding on the panel stack to prevent edge damage.

ZIP System® Roof & Wall Sheathing Notes and Limitations:

- Do not use on roofs with slopes less than 2/12.
- Do not use abutted against general stone or masonry without providing a minimum of a 1/2" gap.
- Do not install ZIP System tape in temperatures less than 20° F
- ZIP System products are not recommended for manufactured housing applications that are built under a federal building code administered by the U.S. Department of Housing and Urban Development (HUD).
- Do not use panel edge clips (H-Clips) with ZIP System Roof & Wall sheathing without expressed written approval from Huber Engineered Woods.**
- Do not use ZIP System tape to permanently seal around circular roof projections (plumbing vents, pipes, curved walls, etc.)

Contents (continued)

Wall Coverings

- ZIP System Roof & Wall sheathing should be covered with the finished roof covering or exterior cladding within 180 days of installation.
- Finished roof and exterior cladding products should be installed per the manufacturer's installation instructions.
- Per the recommendation of the Western Red Cedar Lumber Association and the U.S. Forest Products Laboratory, wood siding should be primed before installation.
- When original roofing or claddings are removed and replaced on existing ZIP System sheathing, the roof or wall should be covered with an additional roofing underlayment or water resistive barrier prior to installation of the new finished roofing or cladding.

Note: In cladding systems requiring multiple layers of water-resistive barriers, like traditional hard-coat stucco, ZIP System sheathing is intended only to replace the first layer.

Wet Blown Cellulose Insulation

- In addition to following manufacturer installation instructions, we recommend a maximum moisture content of the cellulose of less than 25% measured at the inside surface of the ZIP System panel before closing the wall cavity.

Secondary Coatings

Do not apply secondary coatings or treatments to ZIP System Roof & Wall sheathing panels with the exception of the following:

- HEW approved fire resistant coatings. Fire resistant coatings must be tested and approved by HEW for use with ZIP System panels.
- Field applied water-soluble borate insecticide or fungicide treatments applied to the non overlay side of the panel. See technical tip, "Termite Treatments on ZIP System Roof & Wall Sheathing," on zipsystem.com for more information.
- Permeable laminated radiant barrier foil or paint. For a radiant barrier foil or coating to be considered permeable, it must have an applied permeance of five perms or greater as tested by the ASTM E 96 wet cup standard. For a radiant foil, the permeance evaluation would include any adhesive and/or backer used to laminate a foil. For a radiant paint/coating, the permeance evaluation should be conducted at the applied thickness of the paint/coating.

* ZIP System Roof and Wall sheathing replaces only the first layer in multi-underlayment systems.

** Edge support is not required by code with 1/2 (32/16 span rated) and 5/8 (40/20 span rated) performance category sheathing if the framing does not exceed 24" o.c. and the total load does not exceed 93 psf for 1/2 and 156 psf for 5/8 performance categories. This is based on L/180 deflection criteria for total load.

02

ZIP System® Sheathing Installation on Roofs

Overview: ZIP System Roof & Wall sheathing is composed of ZIP System panels and ZIP System seam sealing tape. ZIP System® Roof & Wall Sheathing panels should be fully installed before the seam sealing tape is applied. In general, the ZIP System roof sheathing panels should be installed from the lowest point on the roof to the highest. It is at the discretion of the installer whether to apply tape from the top down or from the bottom up. However, working from the highest sections of the roof and working down will minimize foot traffic on the tape. The following installation steps are presented as guidelines and a general outline of the installation process. These are manufacturer installation recommendations – please visit zipsystem.com for a library of flashing and installation details. You are fully and solely responsible for all safety requirements. Good construction and safety practices should be followed at all times.

Step 1.

- Ensure that the panel surface is dry and clean of any nails, sawdust, or other debris or protrusions prior to installing or walking on the panels.
- After ensuring compliance with all OSHA and local code safety guidelines, install ZIP System sheathing panels with the moisture barrier surface facing outside. The long edge (8') should be oriented perpendicular to the framing members, and panels should be installed with the 4' edge seams staggered a minimum of 24".
- 1/8" spacing between square edges of all adjacent panels is recommended, in accordance with industry standards for wood sheathing. (Tongue & Groove panels are designed to self-space and do not require manual spacing on the 8' edges.)

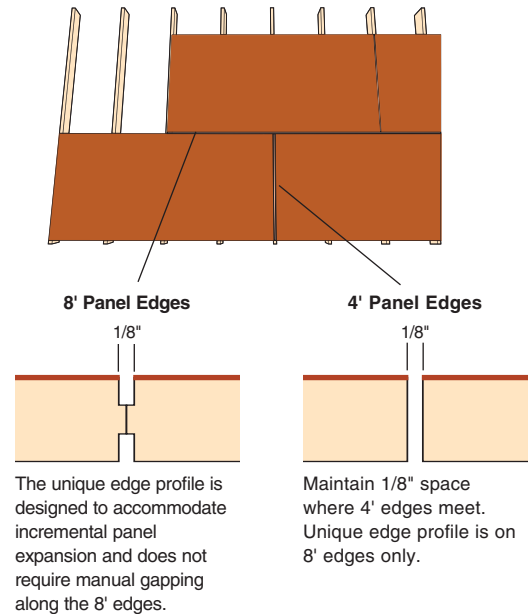

Step 2.

- Ensure that ZIP System panels span at least three framing members and a framing member supports the entire 4' edge of the panels.
- Fasten the ZIP System Roof & Wall sheathing panel to the framing members with code approved fasteners spaced at the appropriate edge and intermediate spacing. It is the responsibility of the general contractor to verify proper fastener type and spacing prior to installation.
- Apply the fasteners 3/8" from the panel ends and corners.
- An ideal installation would be where fastener heads are flush with the panel surface. However, due to variations in materials and limitations on equipment, this may be difficult to achieve in some situations. It is not required to tape over overdriven fasteners unless the fastener head creates a hole through the entire panel thickness. Please see the technical tip, "Overdriven Fasteners in ZIP System Roof and Wall Sheathing," for more information.

Step 3.

Install temporary toe boards as necessary when applying the ZIP System sheathing panels up the slope of the roof planes.

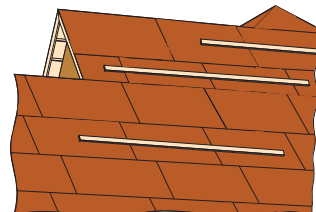

ZIP System™ Tape Installation - Roof Panel Seams

Apply ZIP System tape after all ZIP System Roof & Wall sheathing panels are fully fastened to roof-framing members. Only ZIP System tape should be used to seal the seams of ZIP System panels. Ensure that the panel surfaces are dry and free of any nails, sawdust and other debris, or protrusions. Avoid stepping on tape in high temperature environments. **ZIP System tape is a contact tape that requires pressure for an adequate seal.**

Step 1.

- Apply ZIP System tape to every vertical and horizontal panel seam. It is at the discretion of the installer whether to apply tape from the top down or from the bottom up. However, working from the highest sections of the roof and working down will minimize foot traffic on the tape.
- Ensure that the tape is centered over the seam within $\pm 1/2"$ to provide adequate coverage and to ensure that wrinkles in the tape are minimized.
- Ensure that tape lengths are continuous across the 8' horizontal edge of the panels. If splices are unavoidable, create an overlapping splice of at least 3". Apply moderate pressure onto the surface of the tape to ensure a secure bond between the panel and the tape.
- Use ZIP System tape gun or tape roller to apply pressure to the tape and smooth out any wrinkles.
- Take special care to remove any voids and/or trapped air at splice areas and T-joints.

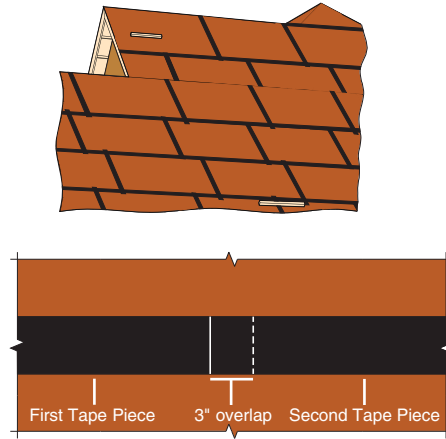

Step 2.

- For valley areas of framing, we recommend you use 6" wide ZIP System tape. This tape is wider than panel seam tape and is designed to give you optimal protection in valley areas.
- Starting from the bottom and working your way up, apply one continuous piece of 6" tape so that the center of the tape is over the valley seam.
- Use the tape gun or tape roller to apply pressure to the tape to ensure proper contact with the panel and to eliminate any wrinkles that might have occurred in the tape. Take special care to seat tape completely into the valley.

Note:

- **It is important to pay extra attention to valley taping as water is directed toward the valleys during rain events.**
- **Self-adhering ice and water barriers may be required by code. ZIP System tape is not considered a replacement for self-adhering ice and water barriers. Therefore, when self-adhering ice and water barriers are required, they should be installed in addition to ZIP System tape.**

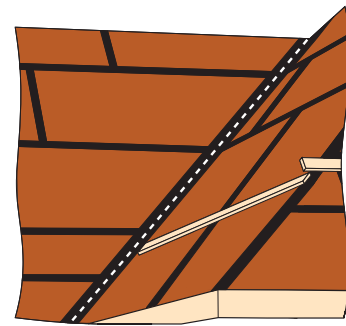

04

ZIP System™ Tape Installation - Roof Panel Seams (continued)

Step 3.

- If 6" ZIP System tape is not available, use two continuous pieces of 3.75" ZIP System panel seam tape over the entire length of the valley seam, overlapping the pieces on the valley seam by at least 1".
- Starting from the bottom, install the first piece of tape overlapping the valley seam by at least 1".
- Use the tape gun or tape roller to apply pressure to the tape to ensure proper contact with the panel and to eliminate any wrinkles that might have occurred in the tape.
- Apply the second piece of tape, overlapping the first piece in the valley seam by 1".
- Repeat use of the tape gun or roller to make sure the tape is adequately adhered and tightly pressed into the valley seam.

Note:

- **It is important to pay extra attention to valley taping as water is directed toward the valleys during rain events.**
- **Self-adhering ice and water barriers may be required by code. ZIP System tape is not considered a replacement for self-adhering ice and water barriers. Therefore, when self-adhering ice and water barriers are required, they should be installed in addition to ZIP System tape.**

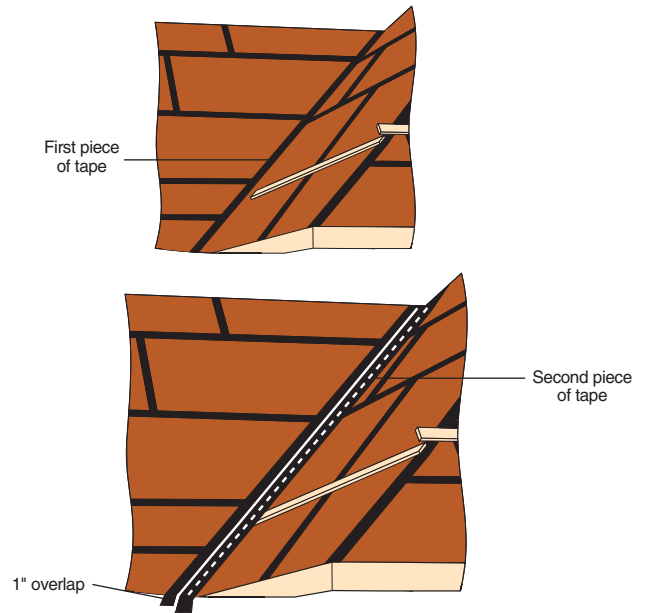

Step 4.

- To provide temporary weather protection to roof/wall intersections of dormers or other wood-sheathed projections, apply 2" of the tape width up the vertical projection from where it intersects with the roof. The remaining tape width can be adhered to the ZIP System roof sheathing panels.
- Use the tape gun or tape roller to apply pressure to the tape and smooth out any wrinkles.

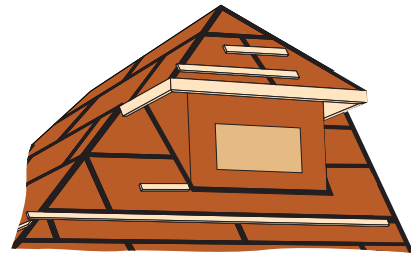

Step 5.

- Install ZIP System tape over hips and ridges by centering the tape over the peak seam. Apply tape in sufficient length to completely extend the length of the hip or ridge.
- Starting from the lowest point of the hip and working up, press tape into place keeping tape centered over the hip. Apply moderate pressure onto the surface of the tape to ensure a secure bond between the panel and the tape.
- Cut ridge tape as required for ventilation prior to installing ridge vent.

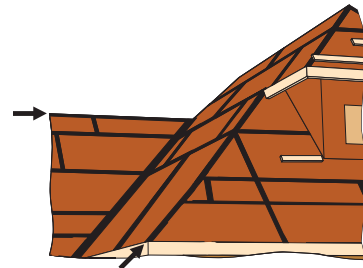

Step 6.

Tape over toe board nail holes once the toe boards are removed, working from the highest toe boards to the lowest.

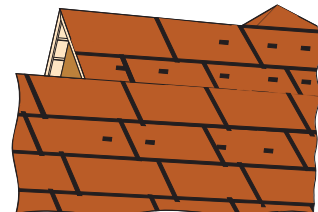

Roof Covering Installation Instructions

ZIP System Roof & Wall sheathing is a code recognized sheathing and underlayment and is approved for use with the following roof coverings:

- Asphalt-fiberglass Shingles
- Metal Roofs (shingles and panels)
- Clay Tile
- Concrete Tile
- Slate and Slate-type Shingles
- Wood Shingles
- Wood Shakes

When installing roof coverings, follow applicable codes and manufacturer's suggested instructions. Some roof coverings require a slip-sheet in addition to conventional underlayment. Where slip-sheets are required, they should be installed over ZIP System sheathing panels.

Note: Visit zipsystem.com for updates and installation details.

Asphalt-fiberglass Shingles

Apply asphalt shingles directly to ZIP System sheathing. For roofs with a slope of 2/12 or greater but less than 4/12, additional underlayment may be required. Install asphalt-fiberglass shingles according to applicable codes and manufacturer's installation instructions.

Metal Roof Coverings

Metal roof coverings may be applied to ZIP System sheathing provided that the roof covering manufacturer's installation instructions and applicable codes are followed.

Fasteners used to secure the ZIP System Roof & Wall sheathing panels to supporting framing must be compatible with the specific metal roof covering used. Galvanized fasteners shall be used with galvanized roof coverings, aluminum-zinc coated fasteners shall be used with aluminum-zinc coated roof coverings and 300 series stainless steel fasteners shall be used with copper roofs. Stainless steel fasteners are acceptable with all metal roof types.

In addition, metal roof flashing shall also be made of a material compatible with the specific metal roof covering used. Apply metal shingles on roofs with slopes of 3/12 or greater.

Clay and Concrete Tile Roof Coverings

ZIP System Roof & Wall sheathing is intended to replace the first layer in a two-layer or multi-layer underlayment system. ZIP System roof sheathing is approved for hot mopping applications. A second layer of underlayment may be hot mopped to the ZIP System sheathing. When installing clay or concrete tile roof coverings, follow the installation recommendations of FRSA/TRI 07320. Install tile roofs according to applicable codes and manufacturer's installation instructions.

Slate and Slate-type Shingles

Apply slate and slate-type shingles on roofs with slopes of 4/12 or greater. Install slate and slate-type shingles according to applicable codes and manufacturer's installation instructions.

Wood Shingles

ZIP System Roof & Wall sheathing is intended to replace the first layer of underlayment required by the IBC and/or the IRC. Additional layers of underlayment may be required by code depending on the local climate. Apply wood shingles on roofs with slopes of 3/12 or greater. Install wood shingles according to applicable codes and manufacturer's installation instructions.

Wood Shakes

ZIP System Roof & Wall sheathing is intended to replace the first layer of underlayment required by the IBC and/or the IRC. Additional layers of underlayment may be required by code depending on the local climate. ZIP System roof sheathing is not to be construed as a replacement for interlayment. Apply wood shakes on roofs with slopes of 4/12 or greater. Install wood shakes according to applicable codes and manufacturer's installation instructions.

06

ZIP System® Sheathing Installation on Walls

Overview: ZIP System Roof & Wall sheathing is composed of ZIP System panels and ZIP System seam sealing tape. ZIP System® Roof & Wall Sheathing panels should be fully installed before the seam sealing tape is applied. The following installation steps are presented as a general outline of the installation process. These are manufacturer installation recommendations – please visit zipsystem.com for a library of flashing and installation details. You are fully and solely responsible for all safety requirements. Good construction and safety practices should be followed at all times.

Step 1. Install ZIP System Roof & Wall sheathing panels positioned with the water-resistive barrier facing outside. The panels may be installed with the long side of the panel oriented either horizontally or vertically to the framing members. Walls that are designed to resist lateral shear forces and sheathed with wood structural panels typically require solid framing or blocking behind all panel edges. If oriented horizontally, block horizontal joints if wall is designed for bracing or as a shear wall.

1/8" spacing between square edges of all adjacent panels is recommended in accordance with industry standards for wood sheathing installation.

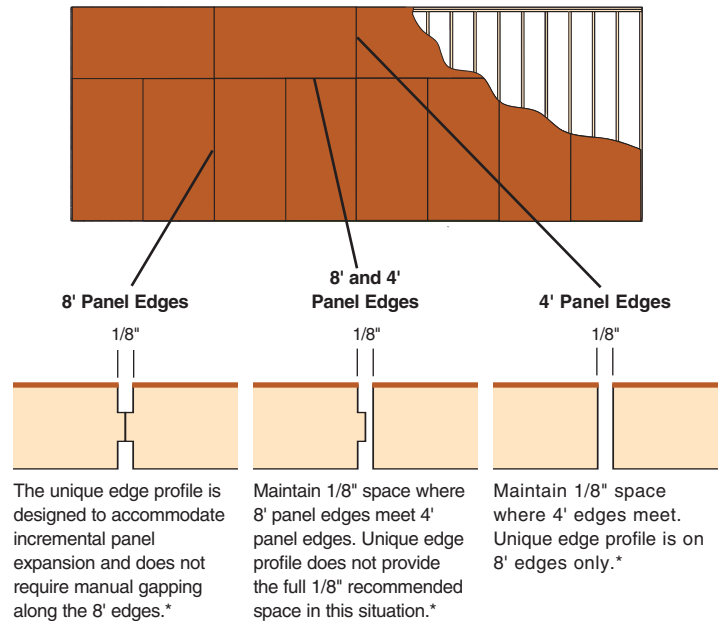

Step 2. Fasten the panels to the framing members with code approved fasteners. Space fasteners 6" o.c. along supported edges and 12" o.c. at intermediate supports, unless otherwise specified by local code or the designer of record. It is the responsibility of the general contractor to verify proper fastener type and spacing prior to installation. Apply the fasteners 3/8" from the ends and corners. An ideal installation would be where fastener heads are flush with the panel surface. However, due to variations in materials and limitations on equipment, this may be difficult to achieve in some situations. It is not required to tape over overdriven fasteners unless the fastener head creates a hole through the entire panel thickness. Please see the technical tip "Overdriven Fasteners in Zip System Roof and Wall Sheathing," on zipsystem.com for more information.

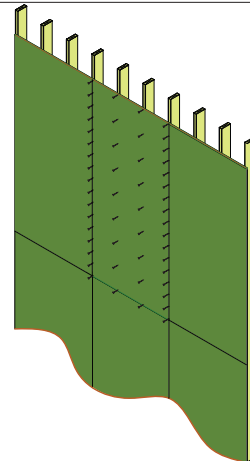

ZIP System™ Tape Installation - Wall Panel Seams

Apply ZIP System tape after all ZIP System Roof & Wall sheathing panels are fully fastened to wall-framing members. Only ZIP System tape should be used to seal the seams of ZIP System panels. Ensure that the panel surface is dry and free of sawdust and dirt prior to taping. **ZIP System tape is a contact tape that requires pressure for an adequate seal.**

Step 1. Tape all seams using ZIP System tape. Ensure that the tape is centered over the seam within +/- 1/2" to provide adequate coverage and that wrinkles in tape are minimal.

Use the ZIP System tape gun or roller to apply pressure to the tape and smooth out any wrinkles.

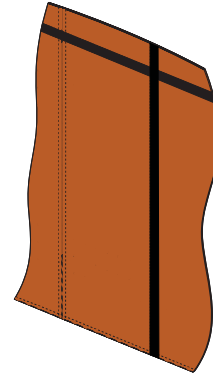

Step 2. Wherever tape splices occur at a horizontal or vertical seam, create an overlapping splice of at least 3".

At T-joints, the tape pieces should overlap by at least 1". Apply moderate pressure onto the surface of the tape to ensure a secure bond between the panel and the tape.

Use the ZIP System tape gun or roller to apply pressure to the tape and smooth out any wrinkles.

Take special care to remove any voids and/or trapped air at splice areas and T-joints.

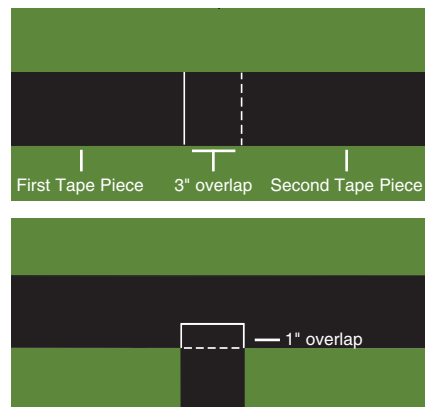

Step 3. Tape inside and outside corner seams.

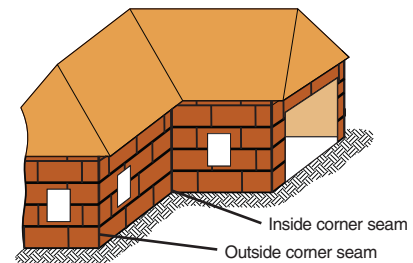

Note: Tape over any areas of the panel or tape that are damaged during construction.

08

ZIP System - Window Installation

DISCLAIMER: The following steps represent a general overview for the proper installation of window flashing. Please defer to/consult the installation instructions of your window manufacturer as well as code requirements in your jurisdiction for full installation details.

Flanged Windows

1. Fasten the ZIP System sheathing to the wood frame and install ZIP System tape to all wall panel seams, as detailed in sections 02 and 03.

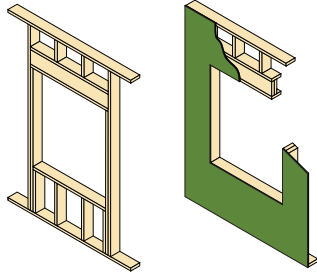

5. Cut a length of ZIP System tape or another adhesive-backed flashing tape (must meet ICC-ES Acceptance Criteria for Flashing Materials (AC148)) and apply to the header, ensuring that the flashing overlaps the jamb flashings.*

Once the tape is in place, use the tape gun or roller to seal the flashing to the sheathing.

*DO NOT tape bottom flange.

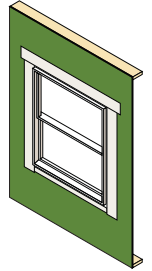

2. ZIP System tape may be used as pan flashing if installed in accordance with flanged window installation details posted on zipsystem.com. Other adhesive-based flashing tapes (must meet ICC-ES Acceptance Criteria for Flashing Materials (AC148)) may be used as pan flashing if installed per ASTM 2112-07. Apply the flashing to cover the bottom of the opening, overhanging onto the sheathing by at least 2" and extending a minimum of 6" up each jamb.

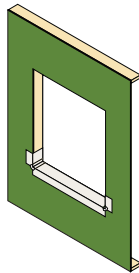

6. From the interior, apply low-pressure polyurethane foam (for windows) between the rough opening and the window frame. (Caulk sealant compatible with the sill flashing may be used at the sill if the opening between the sill flashing and window is too narrow to allow the use of low-pressure polyurethane foam.)

When using ZIP System tape, butyl, 100% silicone or polyurethane sealants are acceptable. Do not use latex sealants with ZIP System tape. If using another flashing tape, follow the flashing manufacturer's recommendation in selecting a sealant compatible with that flashing.

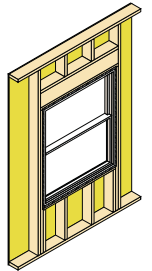

3. Apply sealant around inside face of mounting flange. Sealant must be gapped at the sill to permit drainage. Install and level window per manufacturer's installation instructions. Verify sealant compatibility with window manufacturer. When using ZIP System tape as pan flashing, butyl, 100% silicone or polyurethane sealants are acceptable. Do not use latex or other water-based sealants.

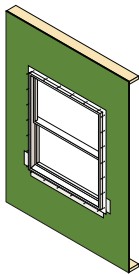

Brick Mould Windows

1. Fasten the ZIP System sheathing to the wood frame and install ZIP System tape to all wall panel seams, as detailed in sections 02 and 03.

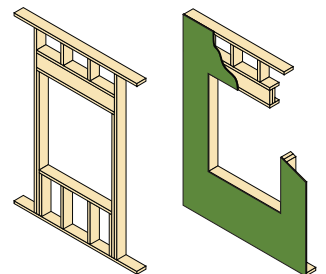

4. Cut two pieces of ZIP System tape or another adhesive-backed flashing tape (must meet ICC-ES Acceptance Criteria for Flashing Materials (AC148)) and apply to each of the window jamb flashings, ensuring the jamb flashings overlap the sill flashing.

Once the tape is in place, use the tape gun or roller to seal the flashing to the sheathing.

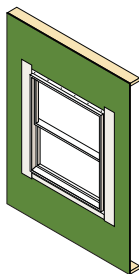

2. If recommended by the window manufacturer, cut a strip of wood to function as a back dam at the sill. The wood strip should have a length equal to the width of the rough opening and a height and width of at least 1/2". Position the block at the inside edge of the window frame.

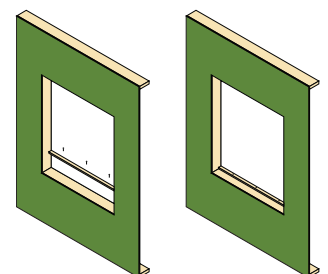

ZIP System - Window Installation

DISCLAIMER: The following steps represent a general overview for the proper installation of window flashing. Please defer to/consult the installation instructions of your window manufacturer as well as code requirements in your jurisdiction for full installation details.

Brick Mould Windows (continued)

3. ZIP System tape may be used as pan flashing if installed in accordance with brick mould window installation details posted on zipsystem.com. Other adhesive-based flashing tapes (must meet ICC-ES Acceptance Criteria for Flashing Materials (AC148)) may be used as pan flashing if installed per ASTM 2112-07. Apply the flashing to cover the bottom of the opening, overhanging onto the sheathing by at least 2" and extending a minimum of 6" up each jamb.

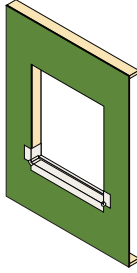

7. Cut a piece of rigid head flashing so that when installed, it is flush with the edges of the exterior moulding of the window. Apply a bead of sealant to the back and bottom surface of the rigid head flashing. Use sealant recommended by the flashing manufacturer.

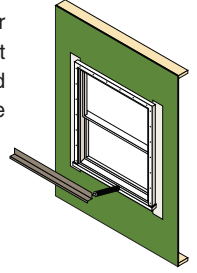

8. Secure the rigid head flashing to ZIP System wall sheathing.

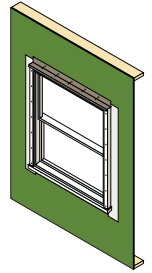

4. For vertical jambs, cut ZIP System tape or another adhesive-backed flashing tape (must meet ICC-ES Acceptance Criteria for Flashing Materials (AC148)) and apply to each of the window jambs. Ensure that they cover the entire inside of the rough opening as well as overlap onto the sheathing by at least 2". Flashing shall also extend above the rough opening, such that it will project 1" beyond the exterior trim of the window.

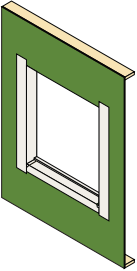

Once the tape is in place, use the tape gun or roller to seal the flashing to the sheathing.

9. Cut a length of ZIP System tape or another adhesive-backed flashing tape (must meet ICC-ES Acceptance Criteria for Flashing Materials (AC148)) and apply to the rigid head flashing, ensuring that the adhesive-backed flashing overlaps the jamb flashings.

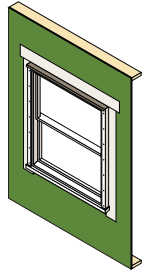

Once the tape is in place, use the tape gun or roller to seal the flashing to the sheathing.

5. Apply sealant to jambs and header allowing for drainage at the sill in accordance with window manufacturer's installation instructions. When using ZIP System tape, use a butyl, polyurethane or 100% silicone sealant. Do not use latex or other water-based sealants with ZIP System tape. When using another flashing tape, follow the flashing manufacturer's recommendations in selecting a sealant compatible with that flashing.

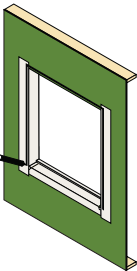

10. From the interior, apply low-pressure polyurethane foam (for windows) between the rough opening and the window frame. (Caulk sealant compatible with the sill flashing may be used at the sill if the opening between the sill flashing and window is too narrow to allow the use of low-pressure polyurethane foam.)

When using ZIP System tape, butyl, 100% silicone or polyurethane sealants are acceptable. Do not use latex or other water-based sealants with ZIP System tape. If using another flashing tape, follow the flashing manufacturer's recommendation in selecting a sealant compatible with that flashing.

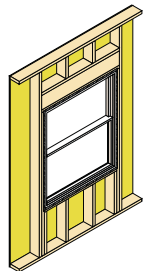

6. Install and level window per manufacturer's installation instructions.

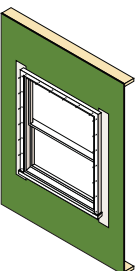

10

ZIP System - Penetration Openings

DISCLAIMER: The following steps represent a general overview for the proper installation of penetration flashing. Please defer to/consult your code requirements in your jurisdiction for full installation details.

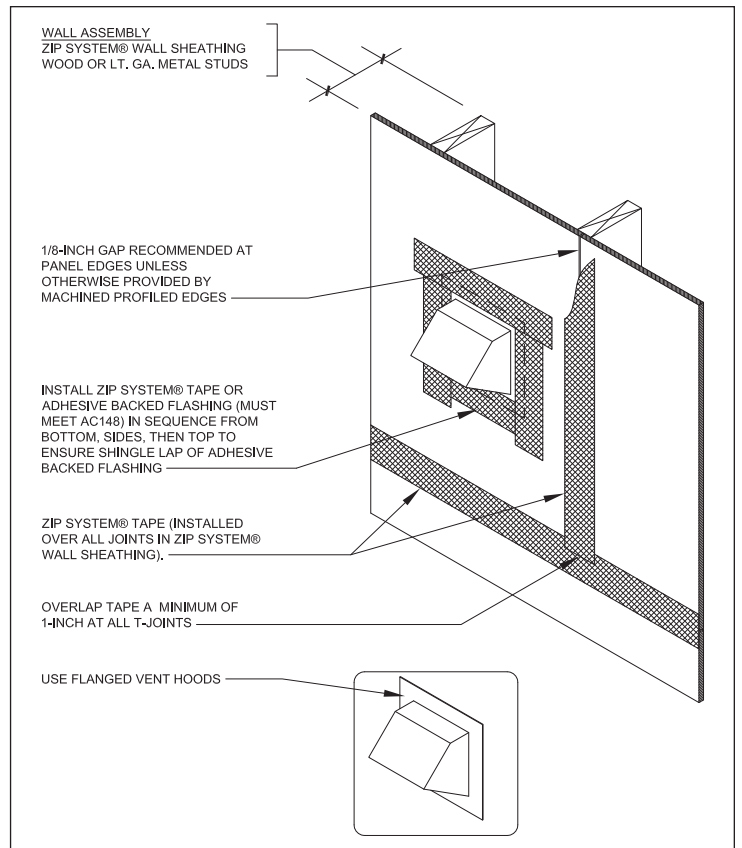
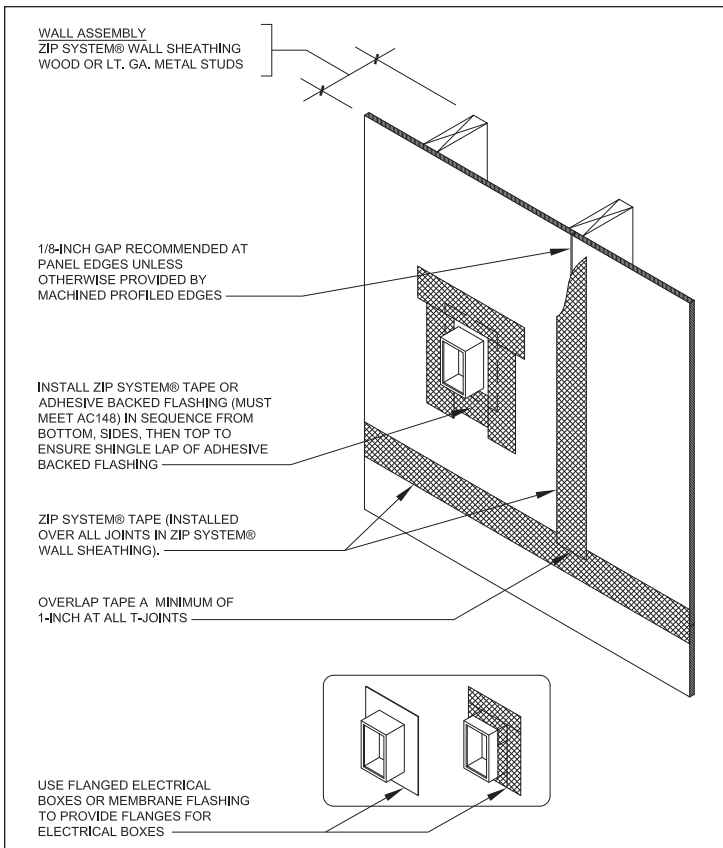
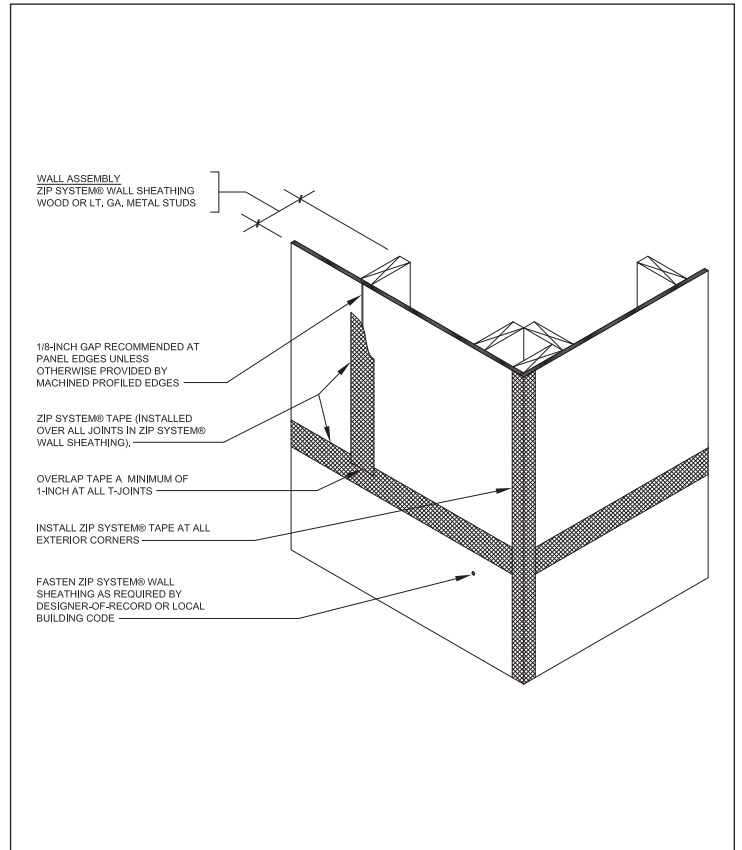
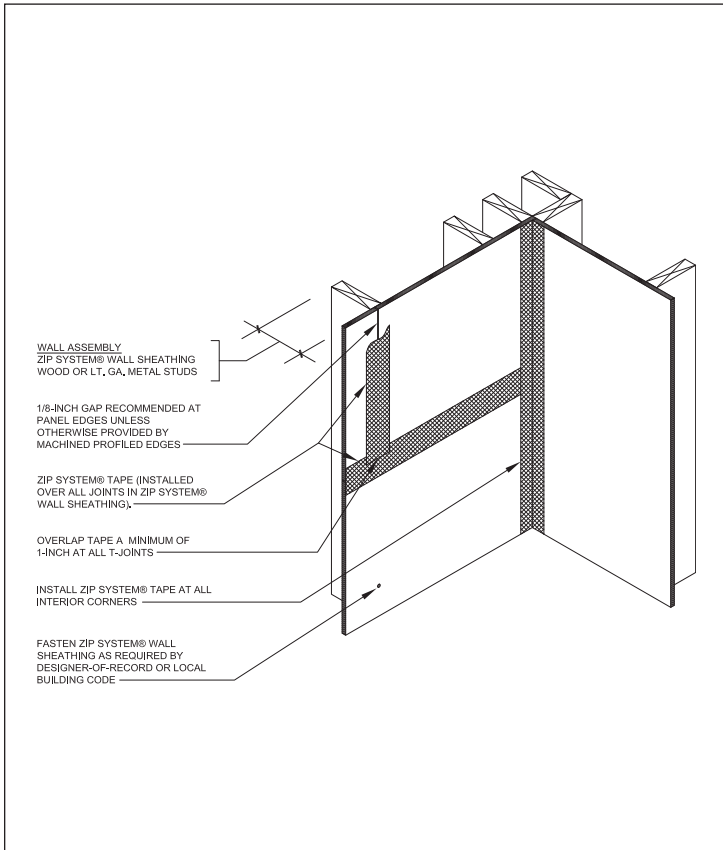

ZIP System Sheathing Installation Details on Walls – visit zipsystem.com for more details.

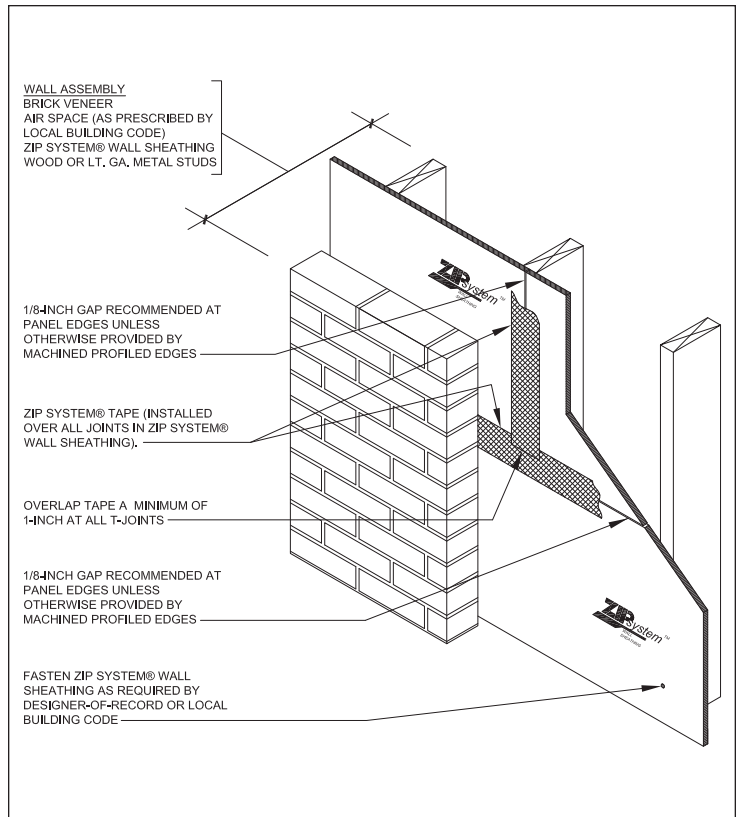
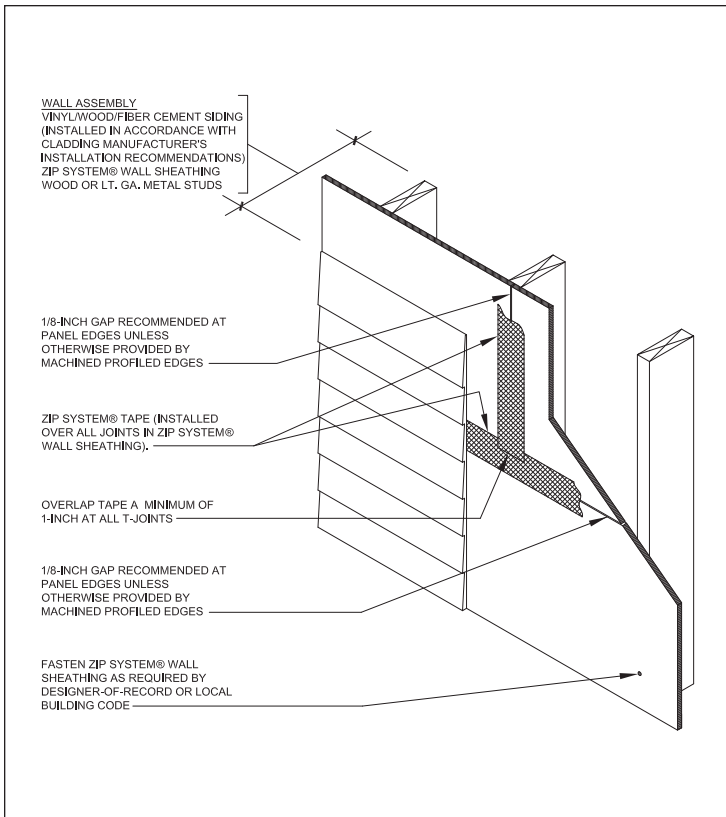
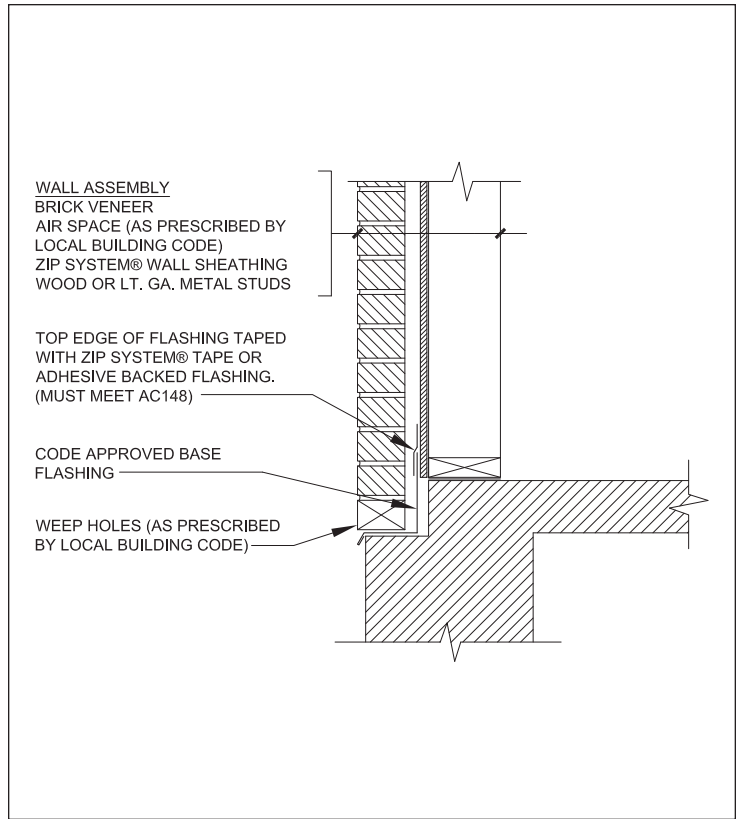
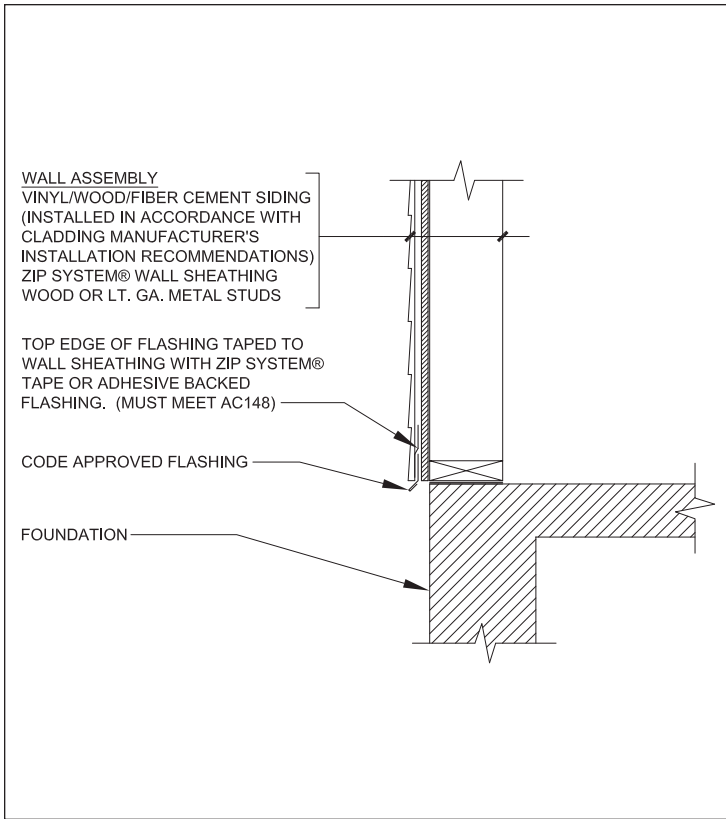

Note: For optimal air leakage reduction, all untaped edges of the panels can be caulked, gasketed or sealed with a weather stripping material.

12

ZIP System Sheathing Installation Details on Walls (continued)

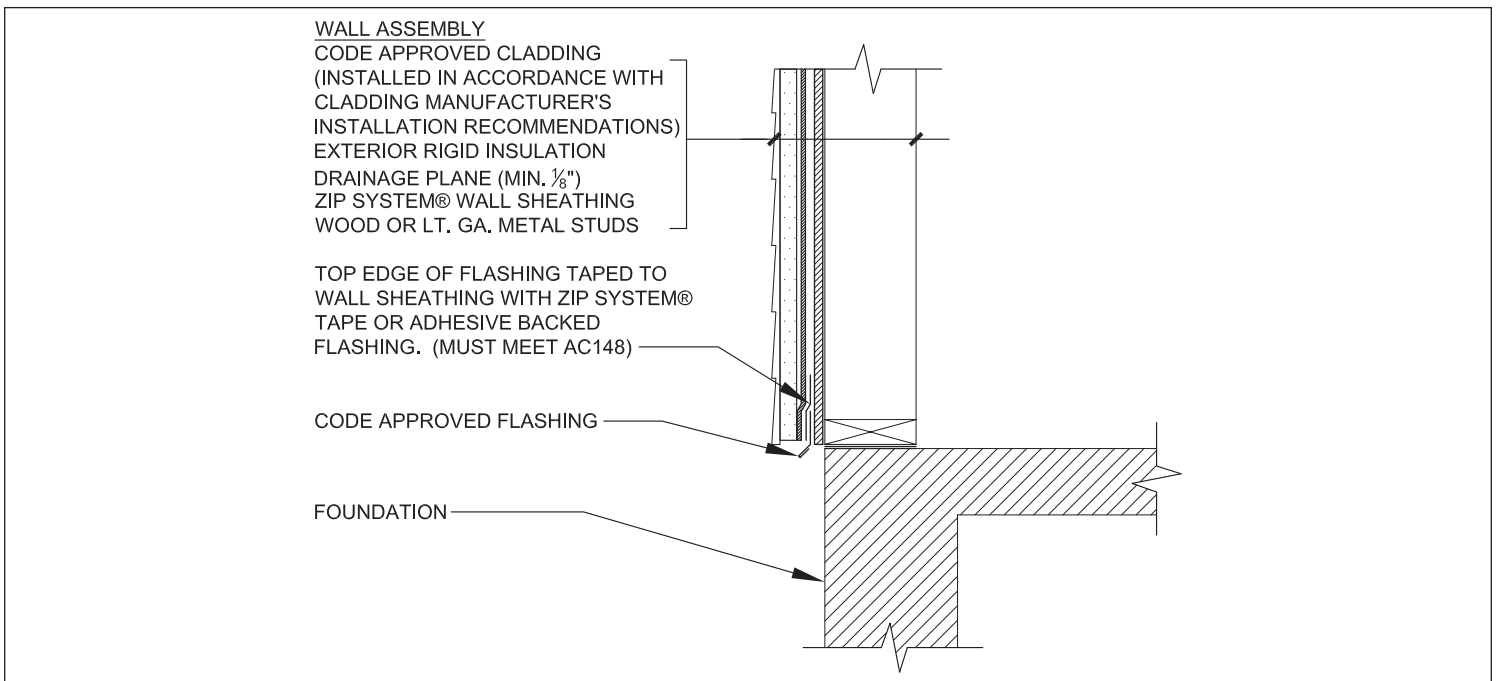
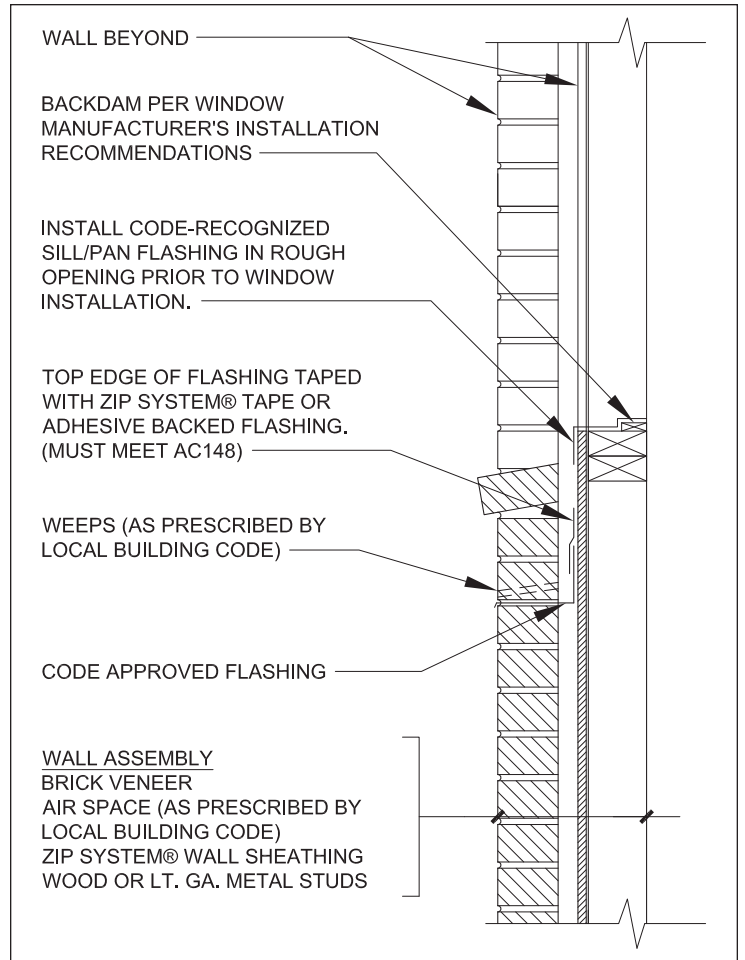
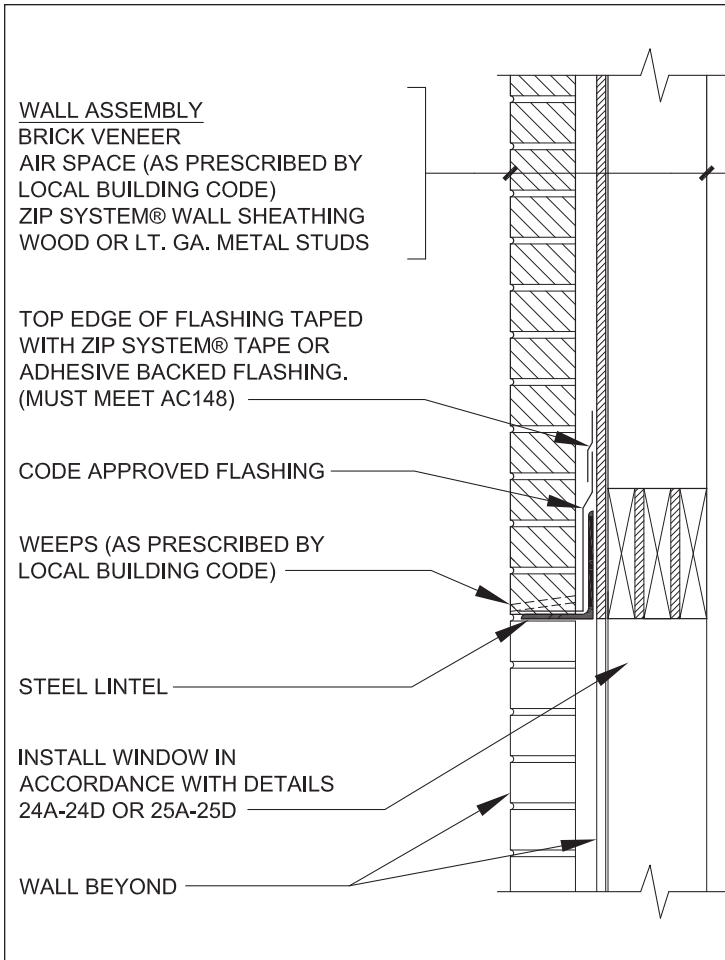

Note: For optimal air leakage reduction, all untaped edges of the panels can be caulked, gasketed or sealed with a weather stripping material.

Printed on 50% recycled paper from sources that have been independently certified for sustainable and well managed forestry practices.

